

M12-A-5

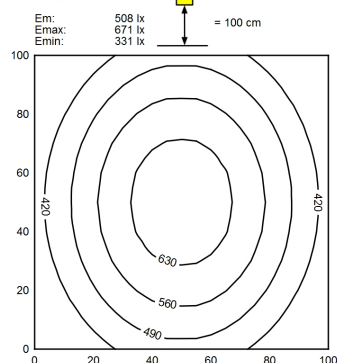
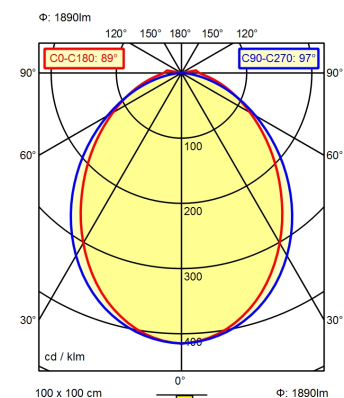

Light source	LED
Work equipment	Without
Connected load	22 - 26 V; DC
Power consumption	ca. 18 W
Luminous flux	approx. 1.890 lm
Light type/-color	Cold white
Colour temperatur	approx. 5.000 K
Color rendering index	CRI ≥ 80
Light distribution	Direct
Beam angle	89° / 97°
Chromaticity tolerance LED	< 4 SDCM
Glare control	Screen
System of protection	IP 54
Class of protection	III
Technology	Switchable; -
Operation	External
Housing	Aluminium/plastic; Anodised, painted; Aluminium coloured anodised Acrylic (PMMA); Satine
Light source cover	
Weight (net)	ca. 0,4 kg
Mains lead	Built-in plug; M12-A-5
Design	mounted version
Fastening	Bracket
Dimension	A=895mm,Cmin=850mm,Cmax=880mm
Minimum ambient temperature	5 °C
Maximum ambient temperature	40 °C
Decorative contrast side parts	Natural silver anodised